



Owner's Manual.

PT500

7ft Pool Table

www.viavito.com

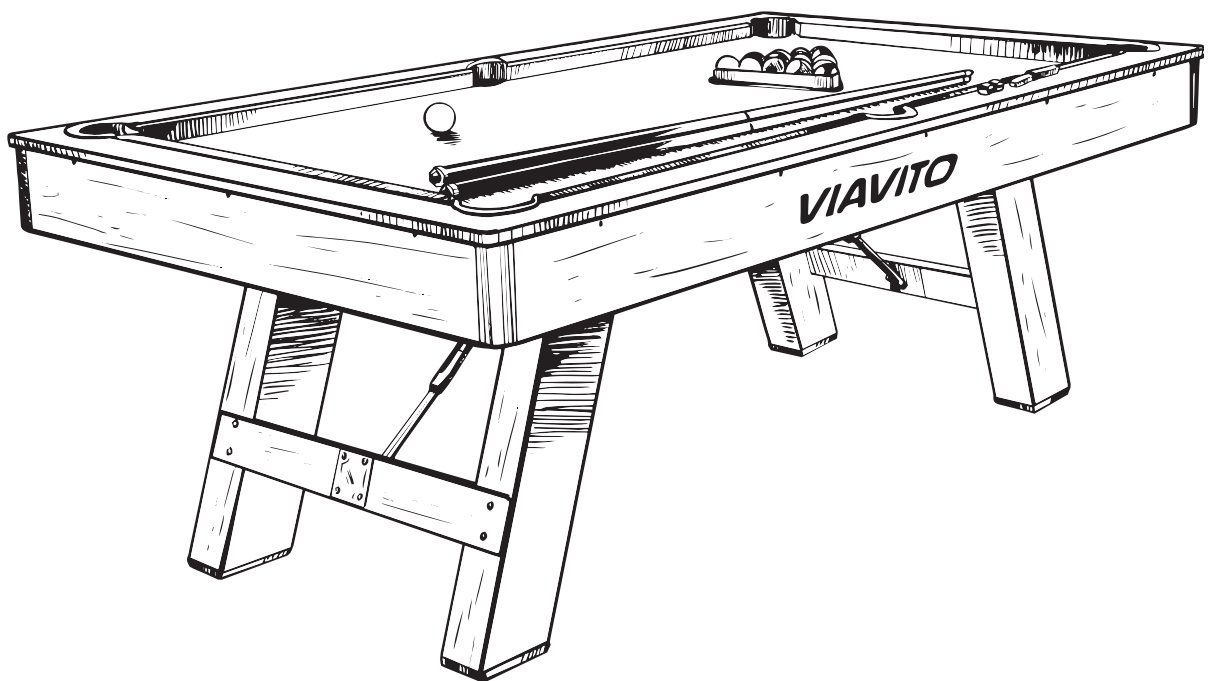

Manual version 1.0



Congratulations on purchasing your very own **PT500** Pool Table.

You have chosen a high-quality, safe and innovative product, and we are certain it will keep you entertained for hours.

Please take the time to read this owner's manual as it will help you to get the most out of your new product.

For more information, or if you require any assistance please email us at **support@viavito.com**

Manual Contents.

Safety Information	03
<hr/>	
Assembly	04/11
Contents Checklist	04/05
Assembly Instructions	06/11
<hr/>	
Maintenance and Care	12
<hr/>	
Customer Support	13/14
Contact Information	13
Manufacturer's Warranty	14
<hr/>	
Technical Information	15/16
Parts List	15
Exploded Diagram	16



Safety Information.

- Please read all instructions carefully before using this product.
- Retain this manual for future reference.
- The specifications of this product may vary slightly from the illustrations and are subject to change without notice.

IMPORTANT SAFETY NOTICE:
note the following precautions before using the product.

- 01** Assemble the product exactly as per the instructions in this manual. We recommend that two adults work together to assemble this table.
- 02** Check all the bolts, nuts and other connections before using the table for the first time and ensure that it has been built correctly and is safe to be used.
- 03** Set up the table in a dry, level place and keep it away from moisture and water.
- 04** This product is intended for home, indoor use only.
- 05** Choking hazard! Keep small parts and polybags away from children during and after assembly.
- 06** Not suitable for children under 3 years of age.
- 07** Only use the table for its intended purpose.
- 08** Damaged or worn parts may be dangerous for users and the integrity of the table. Replace worn or damaged components immediately and do not use the table until any issues have been resolved. Use only spare parts supplied by Viavito.
- 09** Unauthorized repairs or altering the table's design or functions may be dangerous and will void the warranty.









SAFETY STANDARDS

This product meets the requirements of European safety directives

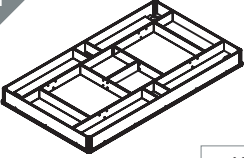
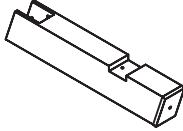
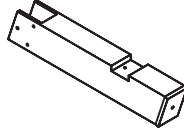
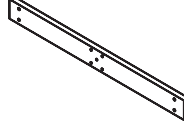
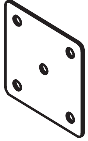
Assembly.

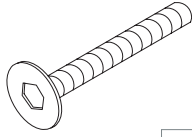
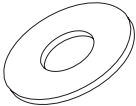
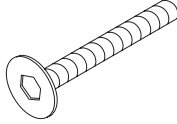
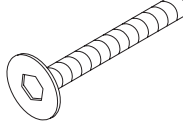
Contents Checklist

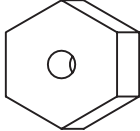
Before you begin the assembly, remove all of the contents from the box and make sure that you have all the parts listed and in correct quantities. This will ensure the quickest and most organized assembly.

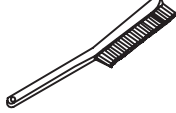
<p>#1</p>  <p>x1</p> <p>Main Frame</p>	<p>#2</p>  <p>x2</p> <p>Leg Type A</p>	<p>#3</p>  <p>x2</p> <p>Leg Type B</p>	<p>#4</p>  <p>x2</p> <p>Leg Panel</p>
<p>#5</p>  <p>x4</p> <p>Metal Plate</p>	<p>#6</p>  <p>x2</p> <p>Metal Plate with Ring</p>	<p>#7</p>  <p>x4</p> <p>Leg Leveler</p>	<p>#8</p>  <p>x12</p> <p>5/16" *1-3/8" Bolt</p>
<p>#9</p>  <p>x12</p> <p>5/16" Washer</p>	<p>#10</p>  <p>x18</p> <p>1/4" *1-3/8" Bolt</p>	<p>#11</p>  <p>x8</p> <p>1/4" *1-1/2" Bolt</p>	<p>#12</p>  <p>x36</p> <p>1/4" Washer</p>
<p>#13</p>  <p>10</p> <p>1/4" Lock Nut</p>	<p>#14</p>  <p>x2</p> <p>Support Strut</p>	<p>#15</p>  <p>x1</p> <p>Allen Key</p>	<p>#16</p>  <p>x1</p> <p>Brush</p>

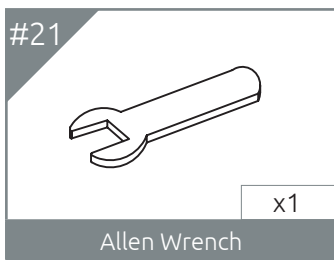
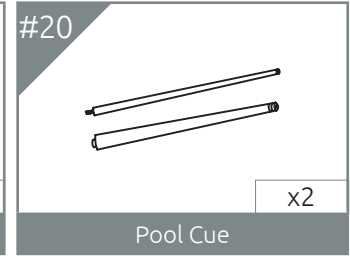
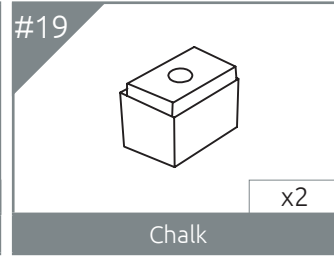
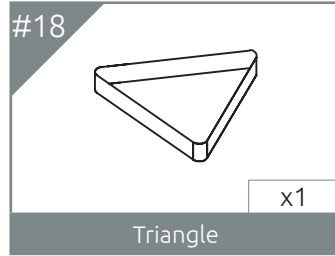
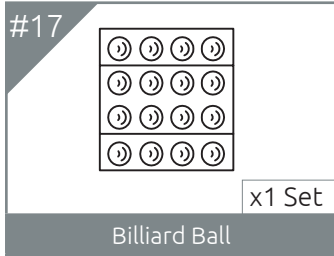

Assembly Instructions

Find a clean and level surface to begin the assembly of your pool table. The table will be assembled upside down and then turned over onto its legs. Turning over the table will require at least two strong adults.

Your table comes mostly pre-assembled. Follow these easy steps to quickly and safely put the table together and get it ready to start playing.

Step One.

01 Attach **(#6) Metal Plate with Ring** to the **(#1) Main Frame** of table as pictured below using **(#10) Bolts** with **(#12) Washers**.

02 Repeat this step on the other side.

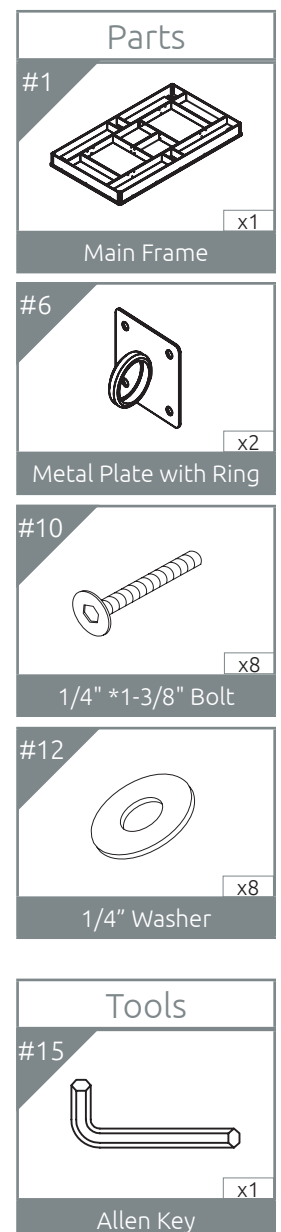
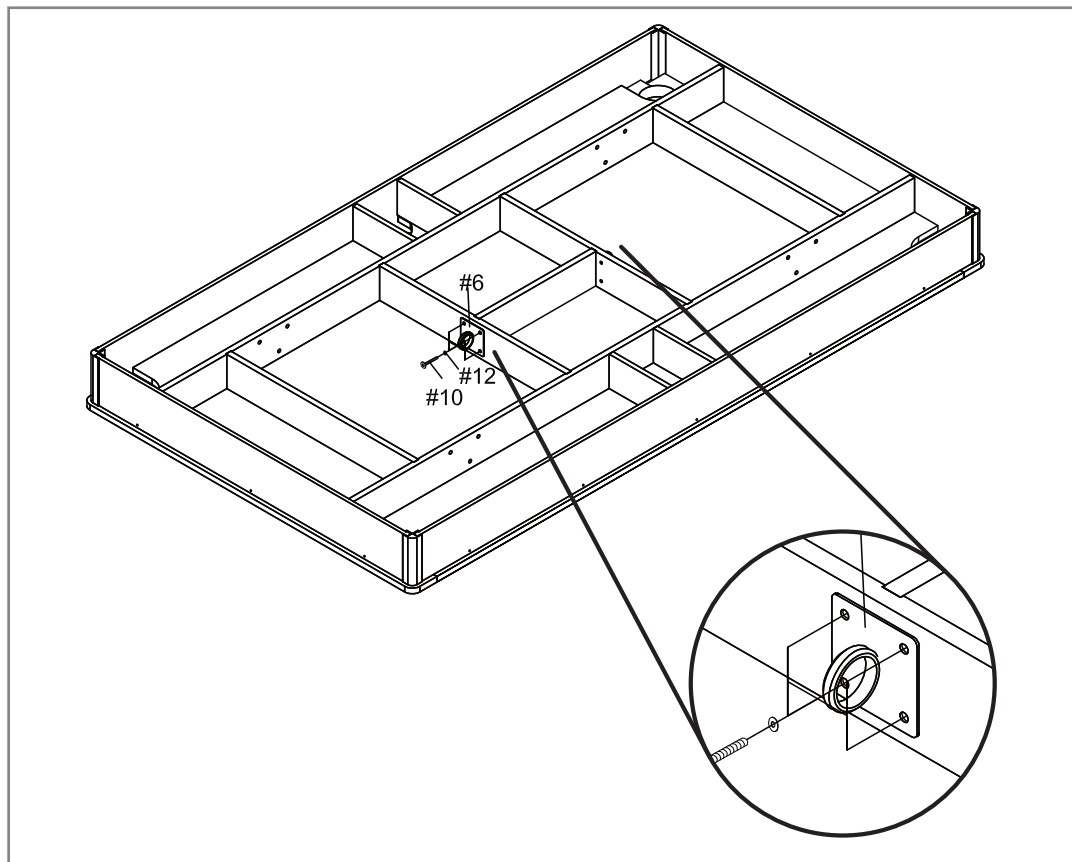

Step Two.

01 Attach **(#5) Metal Plates** to the **(#4) Leg Panel** using four **(#10) Bolts** with **(#12) Washers**. Fasten the leg panels and metal plates using **(#13) Nuts** with **(#12) Washers**.

02 Repeat above steps for the second leg panel.

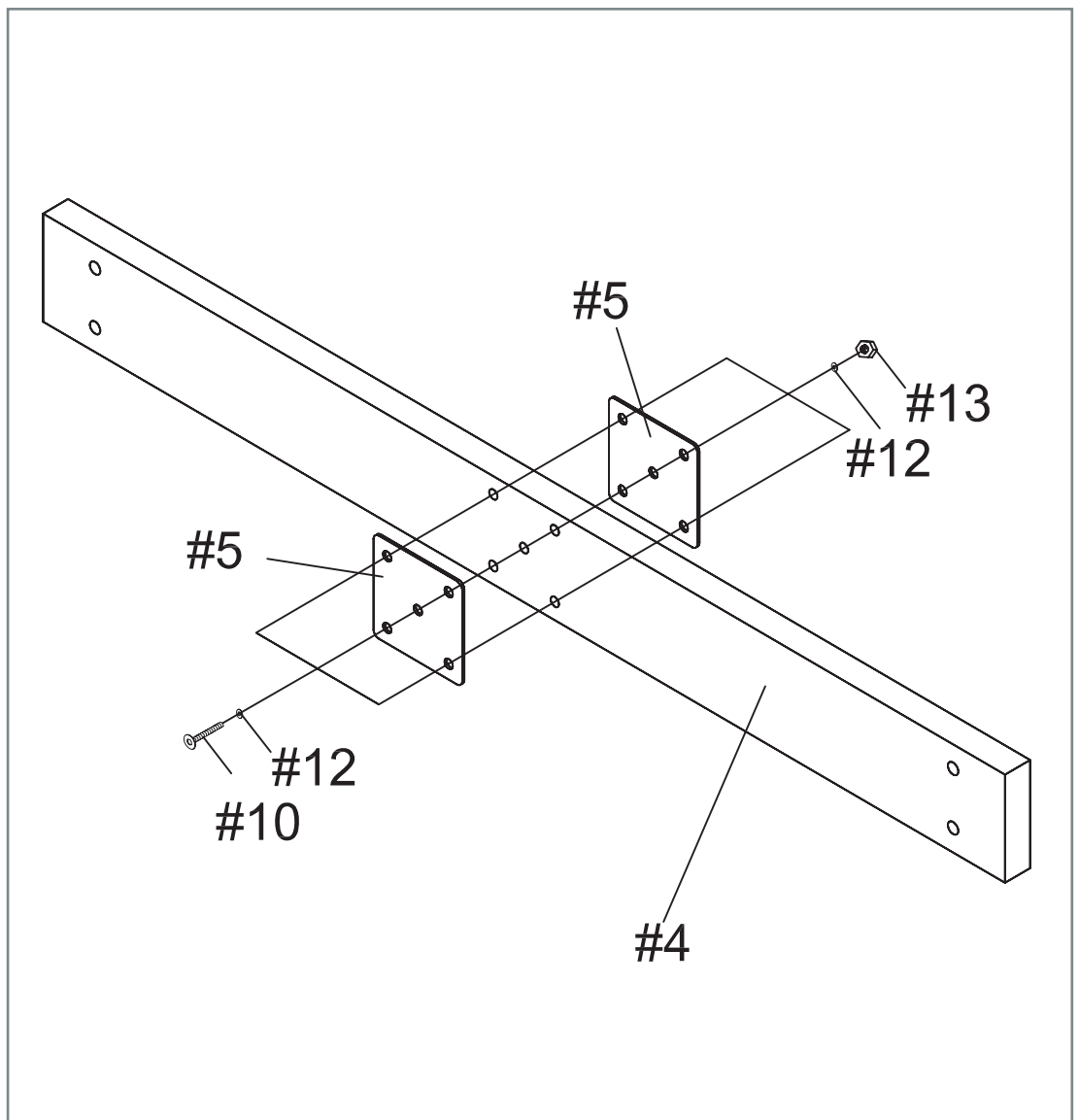
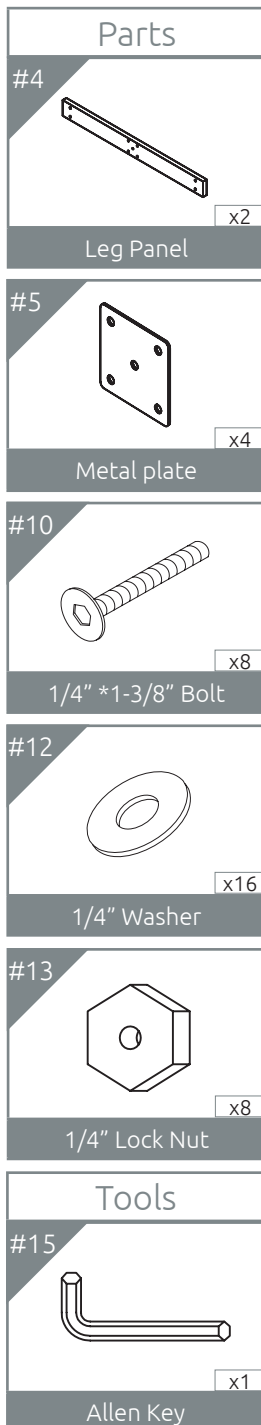

Step Three.

01 Secure **(#2) Leg Type A** and **(#3) Leg Type B** to the table as shown on the drawing below using **(#8) Bolts** and **(#9) Washers**.

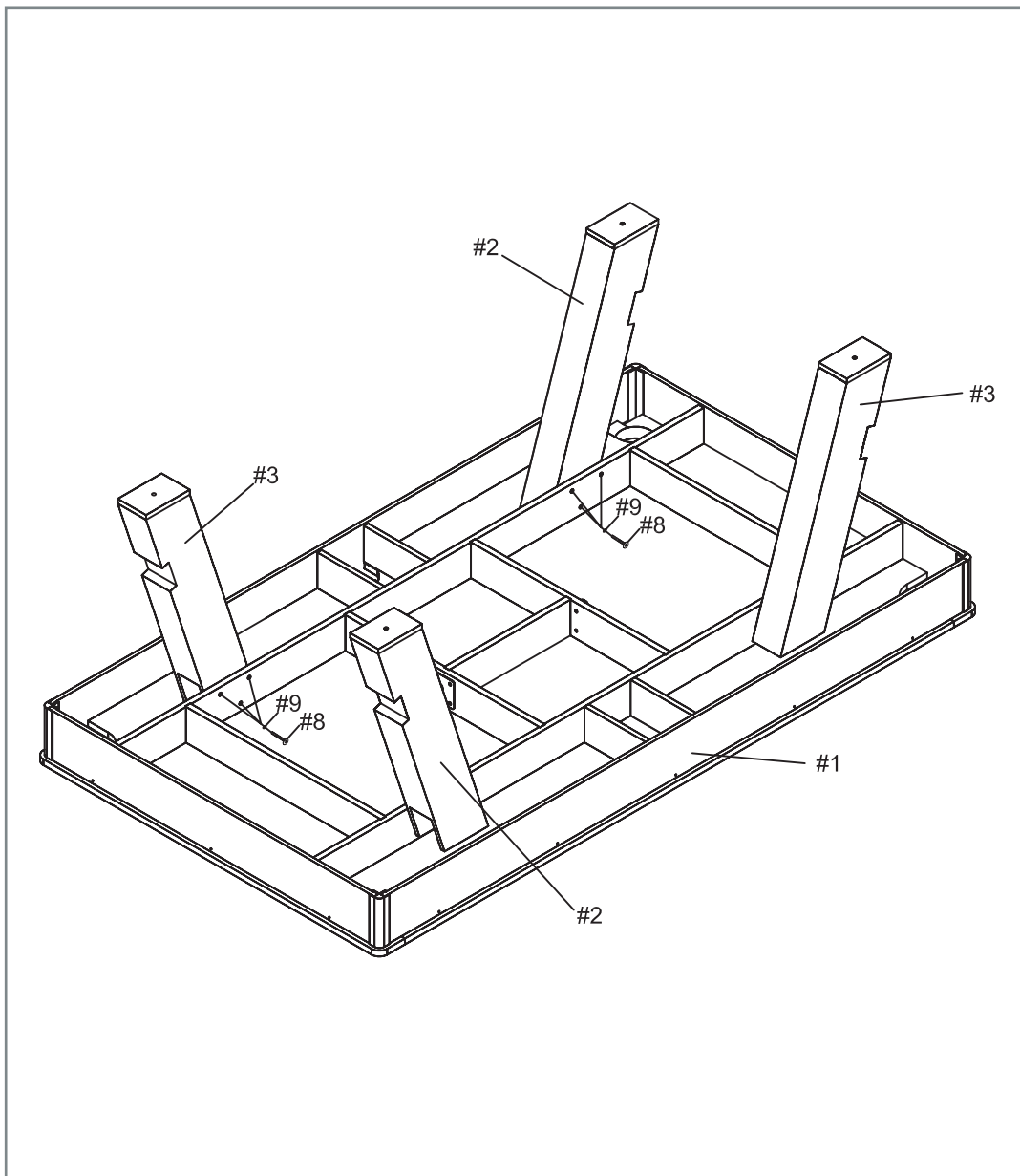

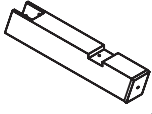
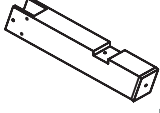
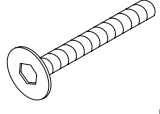
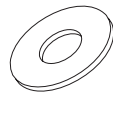
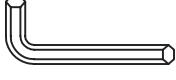
Parts	
#2	 x2 Leg Type A
#3	 x4 Leg Type B
#8	 x12 5/16" *1-3/8" Bolt
#9	 x12 5/16" Washer
Tools	
#15	 x1 Allen Key

Step Four.

01 Connect **Left** and **Right legs** using the panels assembled in the previous step using **(#11) Bolts** and **(#12) Washers**.

02 Attach one **(#7) Leg Leveller** to the bottom of each leg.

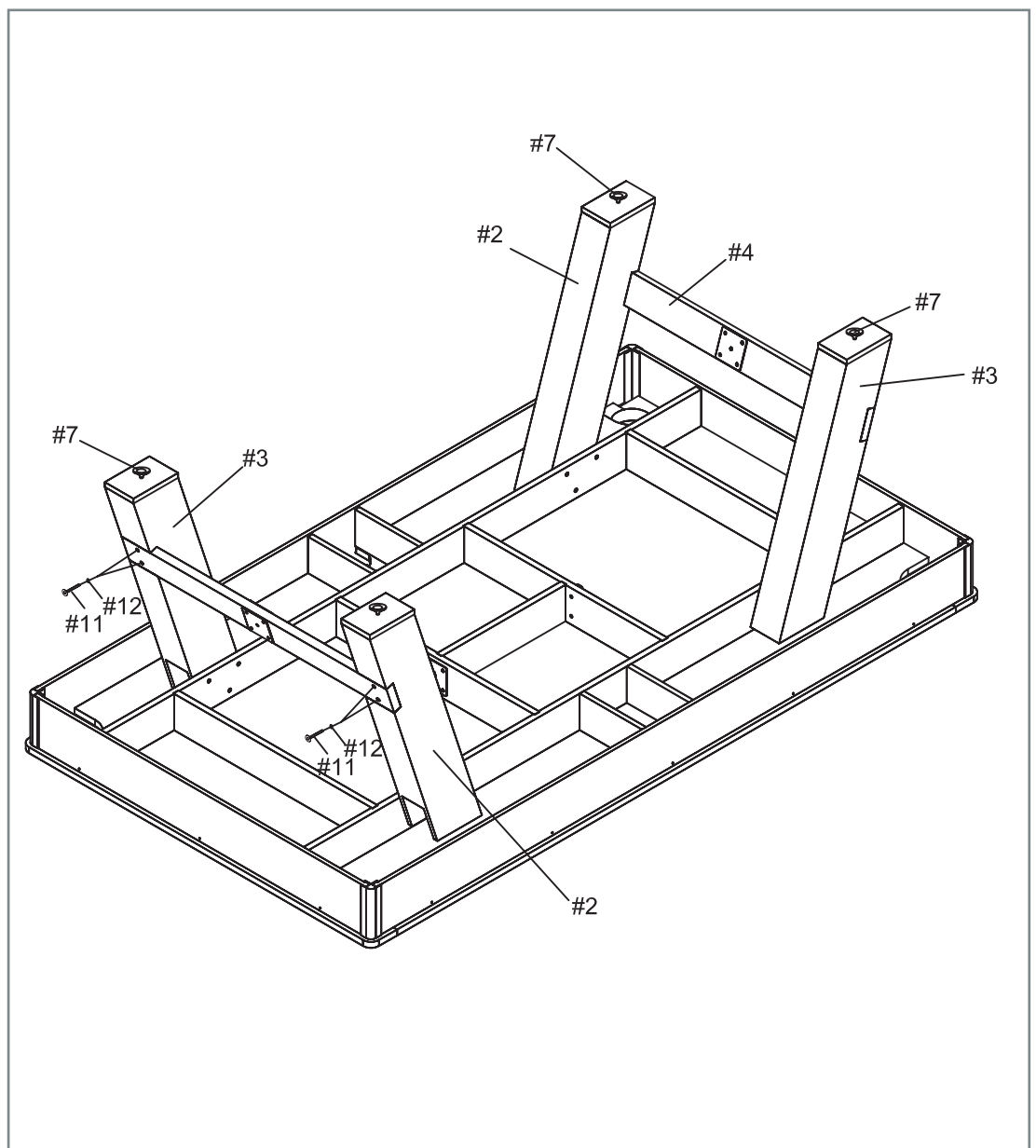
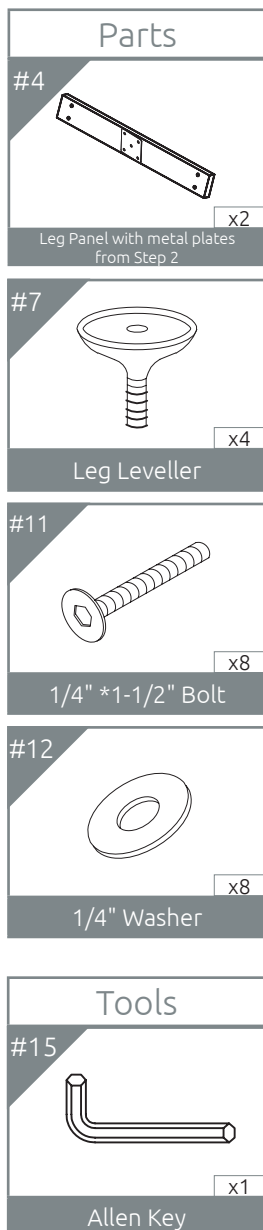

Step Five.

- 01** Using **(#10) Bolt** with **(#12) Washer** attach **(#14) Support Strut** to the metal plate of the leg panel. Tighten the bolts using another **(#12) Washer** and **(#13) Lock Nut** on the other side of the panel.
- 02** Hook the other end of the **(#14) Support Strut** into the metal ring of the support brace.
- 03** Repeat as above for the second support strut.

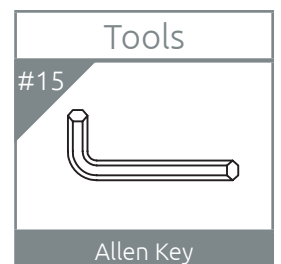
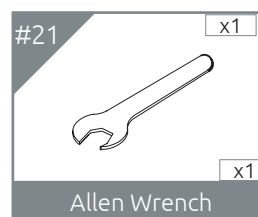
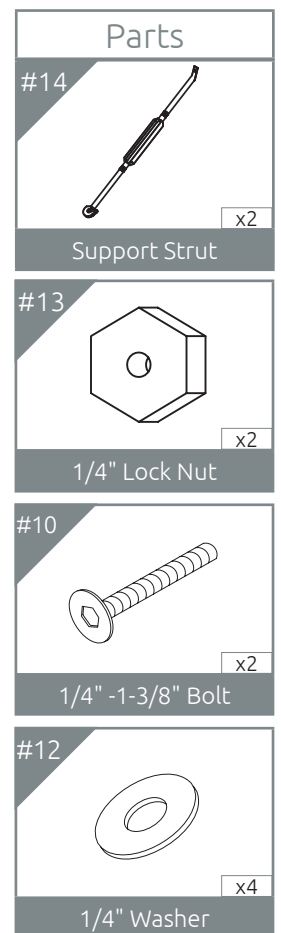
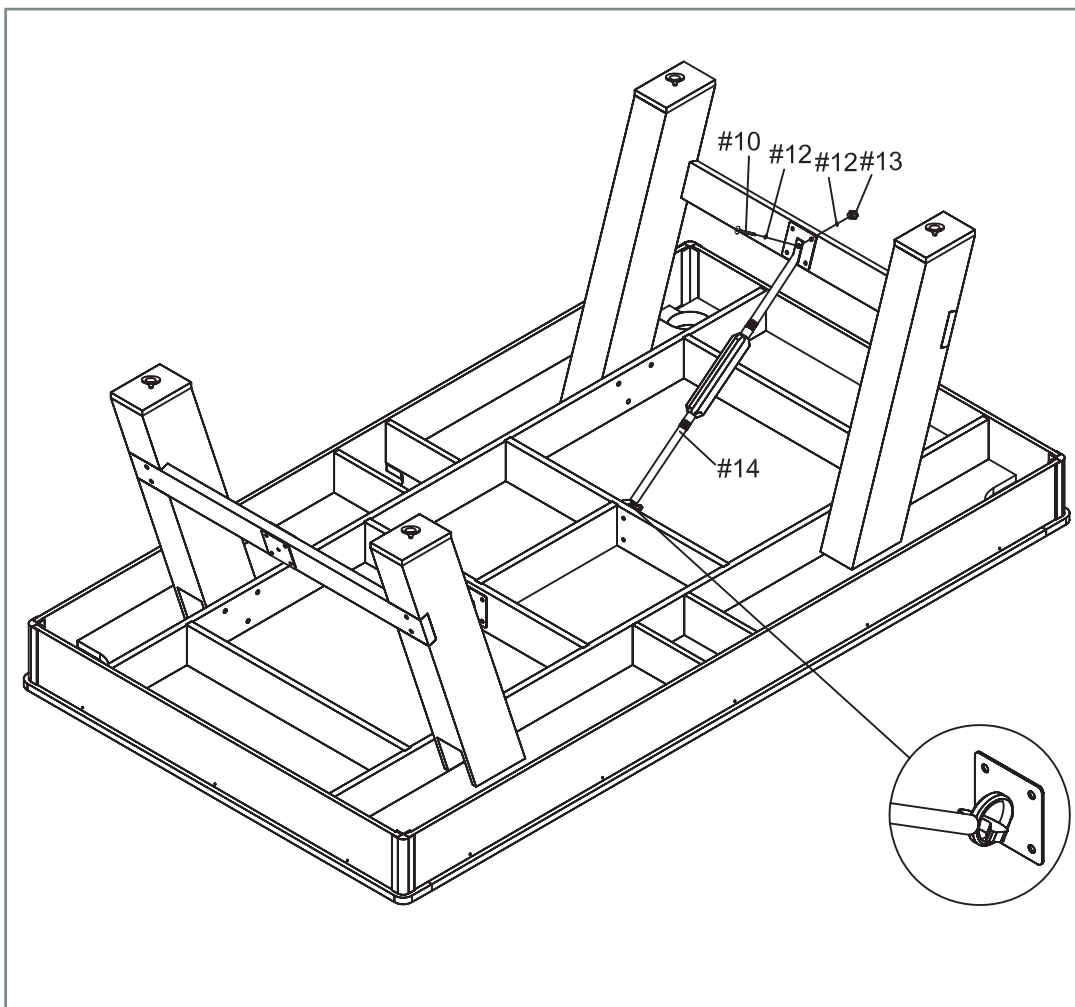

Step Six.

01 Turn the pool table over.



CAUTION!

- 1: It is recommended that two adults turn the table over.
- 2: Take hold of the table as shown.
- 3: Turn the table over.
- 4: Place the table on all four feet at the same time.

Take hold of the table.

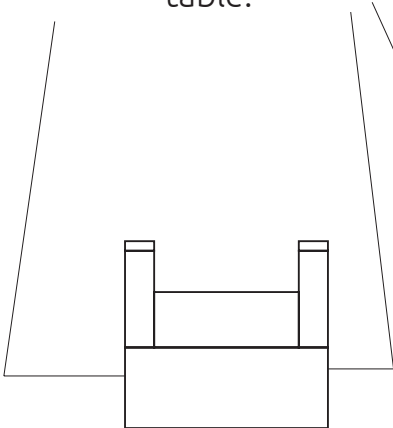

DO NOT hold the table by the legs.

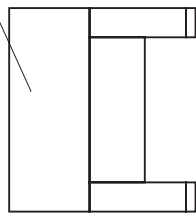

DO NOT lean the table on its legs.

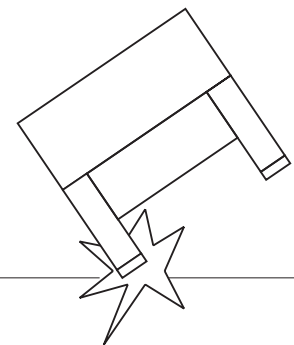
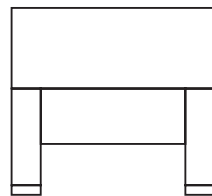

Please note: The PT500 table comes without markings. This allows you to set up the table for a variety of games including both snooker and pool.



Maintenance and Care.

- 01** We recommend that you keep the table covered when not in use. This will prevent dust from building up and will prolong the life of your pool table. If it does get dusty, use a clean, dry cloth to remove any of the loose dirt from the table. Do not use any cleaning products.
- 02** Use the table brush provided to clean the cloth on the table.
- 03** This table is designed for indoor use only. Damage can occur if the table is exposed to water, dampness, high humidity, extreme temperatures, etc.
- 04** Do not sit, climb or lean on the table.
- 05** Periodically check all bolts and nuts to make sure that they are secure and in good working condition. If loose, tighten with an allen key or allen wrench.
- 06** Do not drag the table when moving it as this will damage the legs.



Customer Support.

Contact Information

Should you require any assistance regarding this product please gather the following information and then contact us using the details below:

- Original purchase date
- Place of purchase
- Information about the place and conditions of use
- Precise description of the issue or defect.

IMPORTANT!! - Please retain your sales receipt. Viavito Customer Care may request proof of purchase to validate eligibility for warranty service. Warranty cover starts from the date shown on the proof of purchase.

The best way to contact us is via the website: **www.viavito.com**

Viavito

Unit 8, Sabichi House

5 Wadsworth Road

Perivale, Middlesex

UB6 7JD

Email: **support@viavito.com**



<https://www.facebook.com/MyViavito>



<https://instagram.com/Viavito>



<https://twitter.com/MyViavito>



Manufacturer's Warranty

Viavito warrants this product to be free of defects of material and workmanship, under normal use and conditions, for a period of 6 months from the date of the original purchase.

Terms.

This warranty extends only to the original purchaser and is not transferable. The warranty does not cover:

- 01** Normal wear and tear
- 02** Any changes to upgrade this product from its normal state or use other than as described in the user manual
- 03** Damage resulting from:
 - a) Transport
 - b) Abuse, misuse, failure to follow instructions or improper or abnormal use
 - c) Non-home use - including commercial, professional, or rental purposes
 - d) Repairs not provided by Viavito
 - e) Accidents, lightning, water, fire, or any other causes beyond the control of Viavito
 - f) Improper location including, but not limited to, humid, dusty, or outdoor environments.

Viavito is not responsible or liable for direct, indirect, or consequential losses arising out of or in connection with the use of this product or damages with respect to any loss of property, revenue, profits, enjoyment or use, nor for any costs of removal or installation of this product.

This warranty covers products purchased as new inside the United Kingdom.

This warranty is in addition does not in any way affect your statutory rights.



Technical Information.

Parts List .

PART #	PART NAME	QTY
01	Main Frame	1
02	Leg Type A	2
03	Leg Type B	2
04	Leg Panel	2
05	Metal Plate	4
06	Metal Plate with Ring	2
07	Leg Leveller	4
08	5/16" *1-3/8" Bolt	12
09	5/16" Washer	12
10	1/4" *1-3/8" Bolt	18
11	1/4" *1-1/2" Bolt	8
12	1/4" Washer	36
13	1/4" Lock Nut	10
14	Support Strut	2
15	Allen Key	1
16	Brush	1
17	Billiard Balls	1 set
18	Triangle	1
19	Chalk	2
20	Pool Cue	2
21	Allen Wrench	1

Exploded Diagram

